



WPC FENCING

WOOD POLYMER COMPOSITE
FENCING SYSTEMS

ECO-FRIENDLY &
HIGH END FENCING SYSTEMS

WWW.ARTIGIANODESIGN.COM



WHAT IS WPC ?

Wood Polymer Composite (WPC), also known as Wood Plastic Composite, is an innovative material that blends natural wood fibers with thermoplastics to create a versatile and sustainable building material. The combination of wood and plastic allows for the utilization of the strengths of both components while mitigating their individual weaknesses. WPC typically comprises around 70-80% wood fibers obtained from waste wood products and agricultural residues, and the remaining 20-30% consists of recycled or virgin thermoplastics such as polyethylene, polypropylene, or PVC. This composition results in a material that possesses the visual appeal of wood, including its texture and natural appearance, along with the durability and weather resistance of plastic.

One of the most significant environmental benefits of WPC is its utilization of waste wood materials that would otherwise end up in landfills or be incinerated, contributing to pollution and resource wastage. By repurposing these waste materials, WPC helps reduce deforestation and limits the demand for virgin timber, thereby preserving natural forests and their ecosystems. Additionally, the inclusion of recycled plastics in WPC contributes to recycling efforts, minimizing plastic waste in the environment and reducing the need for new plastic production.



Furthermore, WPC requires less maintenance compared to traditional wood, as it is resistant to decay, insects, and weathering. This longevity reduces the frequency of replacement and lowers the overall demand for raw materials. The energy required for the production of WPC is generally lower than that of traditional wood processing, as it involves fewer steps and does not necessitate extensive drying processes.

As a result, WPC demonstrates a smaller carbon footprint and reduced energy consumption throughout its lifecycle, aligning with sustainable practices and making it an environmentally friendly choice for various applications in the construction and manufacturing industries.

8 ENVIRONMENTAL REASONS TO USE ARTIGIANO'S WPC FENCING SYSTEMS IN YOUR PROJECT



REDUCED WOOD USE

WPC fencing utilizes recycled wood materials, reducing the demand for virgin wood resources. This helps to conserve forests and decrease deforestation, which is vital for maintaining biodiversity and regulating the carbon cycle.



RECYCLED MATERIALS

Both WPC materials (wood and plastic) used in the production are recycled and can be repurposed at the end of their lifespan. This reduces the amount of waste sent to landfills and promotes a circular economy approach.



ENERGY EFFICIENCY

Manufacturing WPC fencing generally requires less energy compared to processing and treating natural wood. This can lead to lower greenhouse gas emissions and a reduced overall environmental impact.



REDUCED CHEMICAL USE

Traditional wood fences often require chemical treatments to resist decay, pests, and weathering. WPC fences reduce the need for such chemical treatments, minimizing the release of potentially harmful substances into the environment.



LONGEVITY & VERY LOW MAINTENANCE

WPC fencing is 100% resistant to rot, moisture, and insect damage. This means that it has a longer lifespan and requires less maintenance, which in turn reduces the need for frequent replacements and the associated environmental impact.



HELPS WATER CONSERVATION

WPC materials do not require staining or painting, reducing the need for water-intensive maintenance activities associated with natural wood fences.



REDUCES LANDFILL WASTE

Due to its durability and long lifespan, WPC fencing generates less waste compared to fences that require frequent replacement.



LOW CARBON FOOTPRINT

By incorporating recycled materials and reducing the need for maintenance and replacements, WPC fencing can have a lower carbon footprint over its lifecycle compared to alternatives like traditional wood or vinyl fencing.

Milano Series



COMPONENTS

Post	Rail	Side Cover	L-fix	Post Base	Cap

COLOR OPTIONS

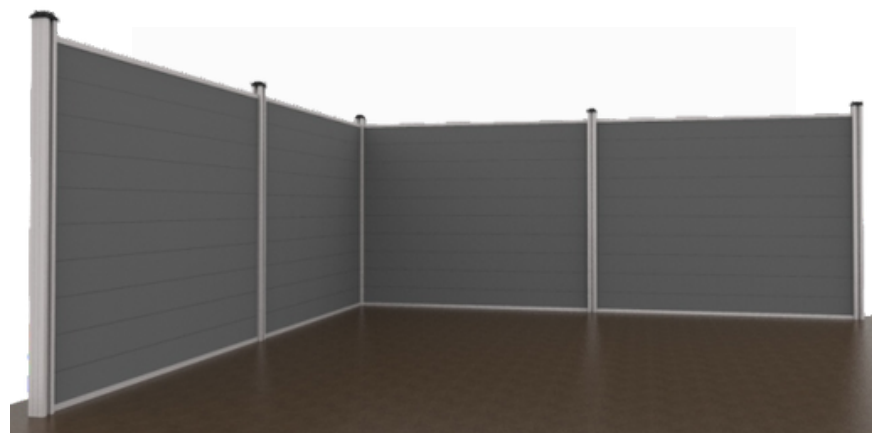

Introducing the esteemed Milano Series, a true favorite among fence enthusiasts. This model has captured the hearts of the Euro market with its exceptional attributes. Set against conventional wire mesh and iron fencing, our offerings cater to a clientele seeking a holistic blend of health-consciousness, organic aesthetics, privacy assurances, and a penchant for DIY projects.

Elevating your outdoor environment with a touch of natural allure, the Milano Series transcends expectations. Its privacy-focused design finds applications as diverse as domestic boundaries, artistic partitions, and household adornments. Witness the convergence of function and style, where the Milano Maestro Series redefines fencing excellence.

Trevi Series



Standard Size:
W1800mm X H1800mm
W1800mm X H1150mm

S-CF01 - 180X24mm
S-CF02 - 90X24mm

COMPONENTS

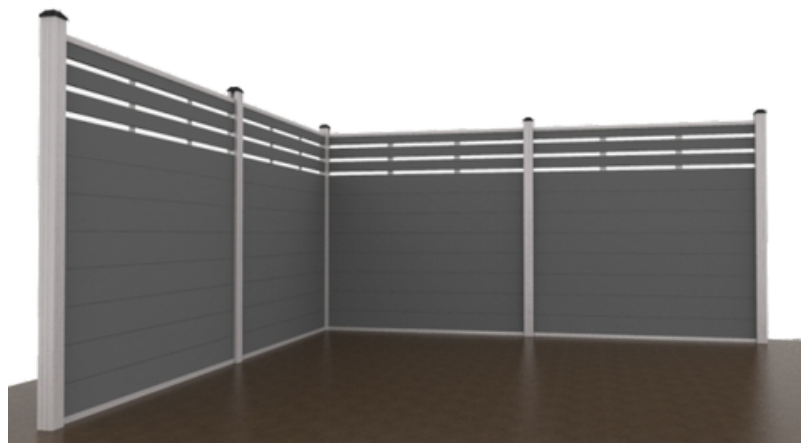

Introducing the Trevi Series, a visionary creation that employs alternating synthetic wood panels on both the front and back, ensuring a harmonious visual experience from every angle. This innovative design ensures a consistent and captivating view on both sides of the fence.

One side boasts a strategic mid-trellis pattern, promoting optimal ventilation and an open ambiance. Meanwhile, on the flip side, this same design fosters privacy, thoughtfully considering the needs of neighboring spaces.

The Trevi Series is a testament to thoughtful design, striking the perfect balance between aesthetic appeal and functional considerations. Elevate your surroundings with this versatile solution, where every perspective is a masterpiece.

Post	Rail	Side Cover	Spacer	L-fix	Post Base	Cap
						

COLOR OPTIONS



Verona Series

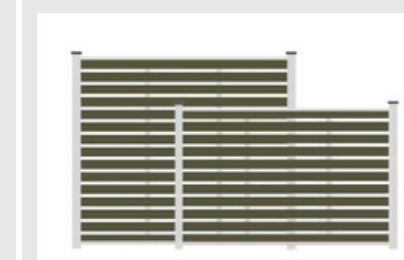

Standard Size:
W1800mm X H1800mm
W1800mm X H1150mm



S-CF02
90X24mm

COMPONENT

Post	Rail	Side Cover	Spacer	L-fix	Post Base	Cap

COLOR OPTIONS

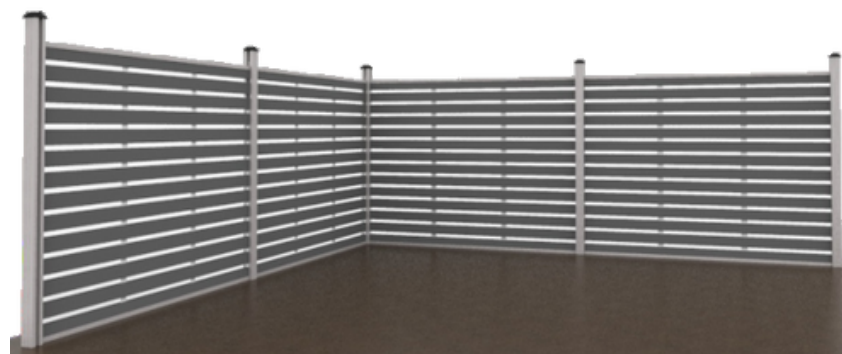

Unveiling the Verona Series, where a seamless horizontal aesthetic is crafted using expansive 90mm composite wood panels. The captivating full-trellis layout is exquisitely tailored for front yard fencing, ingeniously addressing concerns about wind resistance often encountered with privacy-centric designs.

This innovative style not only enhances the visual allure but also elegantly complements garden landscapes or serves as indoor partitions. The Verona Series effortlessly marries form and function, offering an impeccable addition to your environment's aesthetic and practical needs.

Capri Series



Standard Size:
 W1800mm X H1800mm
 W1800mm X H1150mm



S-MF04
 140X11mm

COMPONENTS

Post	Rail	Side Cover	Vertical Tube	L-fix	Post Base	Cap

COLOR OPTIONS

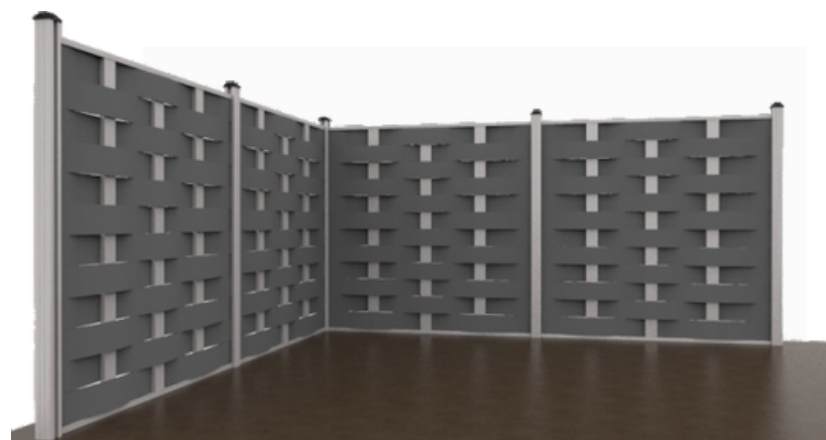

Elegantly shaping both the rear and front fence boards, we've curated the captivating undulations of the Capri Series. This unique curvature imparts a mesmerizing wavelike aesthetic, granting a stunning three-dimensional allure to your surroundings.

The interplay of concave and convex elements creates a visually dynamic experience, enhancing the beauty of your space. Beyond its aesthetic appeal, this design seamlessly integrates privacy protection with optimal ventilation – a harmonious blend of functionality and form.

Resonating particularly well in tropical locales, the Capri Series has garnered popularity for its distinctive attributes. Elevate your environment with this tropical elegance, a testament to meticulous design and thoughtful utility.

Trieste Series

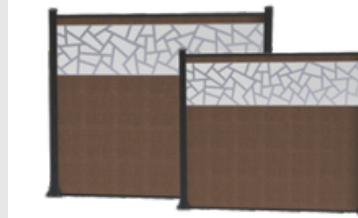

Standard Size:
 W1800mm X H1800mm
 W1800mm X H1150mm



S-CF01-180X24mm
 S-CF02 - 90X24mm

COMPONENTS

Post	Rail	Side Cover	L-fix	Post Base	Cap

COLOR OPTIONS



Presenting the Trieste Series – a masterful blend of time-honored iron fencing and contemporary WPC craftsmanship. This exceptional collection seamlessly marries intricately designed WPC boards with classic metal components, resulting in a captivating array of possibilities.

Whether your preference lies with finely carved WPC boards or meticulously fashioned metal segments, each option showcases unique patterns. This diverse selection caters to various client preferences, enhancing the visual allure of our fencing offerings.

With its thoughtfully designed half-privacy concept, the Trieste Series is ideally suited for enhancing decorative boundary fencing. It effortlessly elevates the ambiance of spaces like coffee shop partitions and leisure areas, making a lasting impression. Embark on a journey of aesthetic revelation with the Trieste Series, where tradition and innovation converge.

Venezia Series

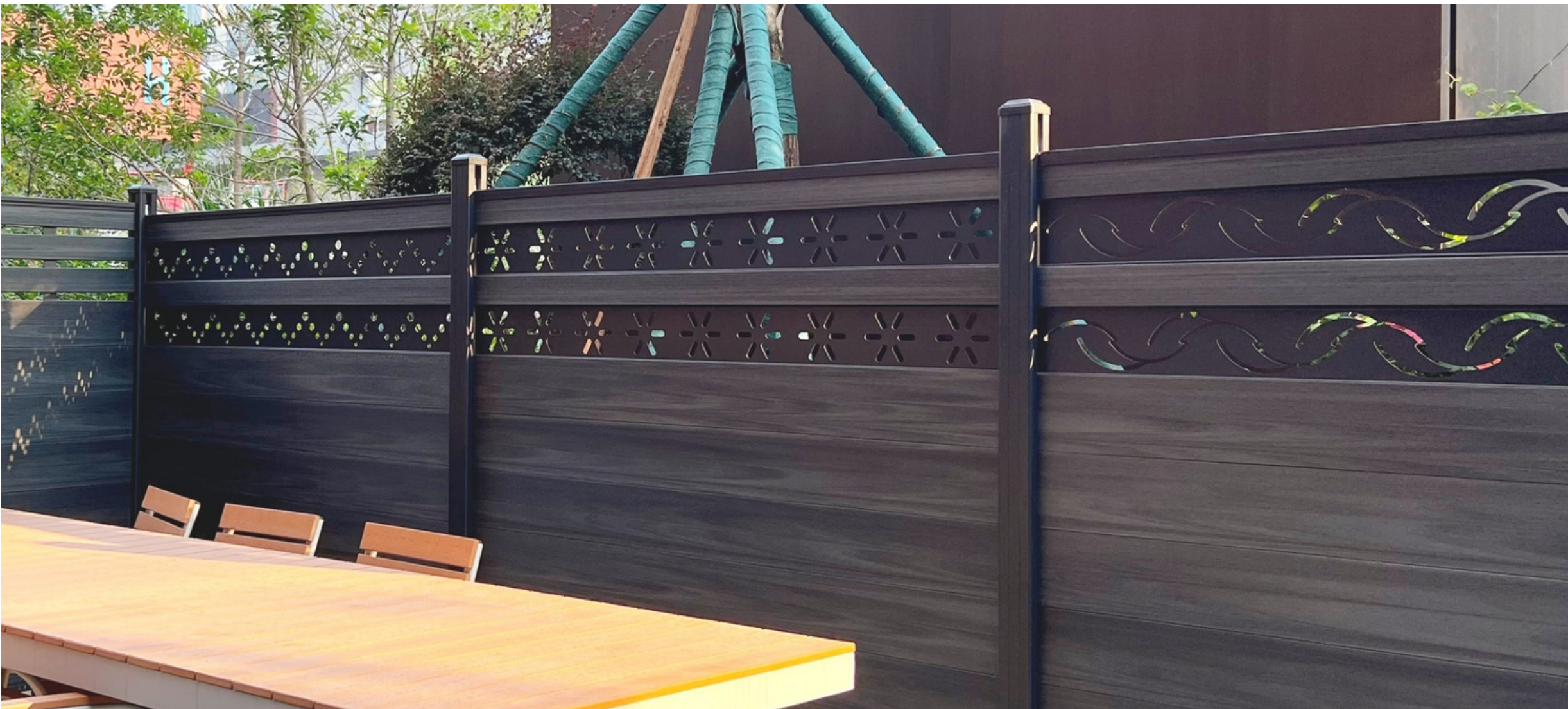

Standard Size:
 W1800mm X H1800mm
 W1800mm X H1150mm



S-CF01 - 180X24mm
 S-CF02 - 90X24mm

COMPONENTS

Post	Rail	Side Cover	L-fix	Post Base	Cap

COLOR OPTIONS



Introducing the Venezia Series – a harmonious fusion of classic iron fencing and modern WPC innovation. This exquisite collection seamlessly blends intricate WPC board carvings with elegant metal elements, offering a versatile range of possibilities.

Choose between delicately carved WPC boards or meticulously crafted metal segments, each presenting a distinct pattern. This diverse selection caters to varied client preferences, elevating the visual impact of our fencing solutions.

With its half-privacy design, the Venezia Series is specifically tailored for decorative boundary fencing, enhancing the aesthetics of spaces such as coffee shop partitions and leisure areas. Elevate your surroundings with the artful charm of the Vista Venezia Series, where tradition meets innovation.

Amalfi Series

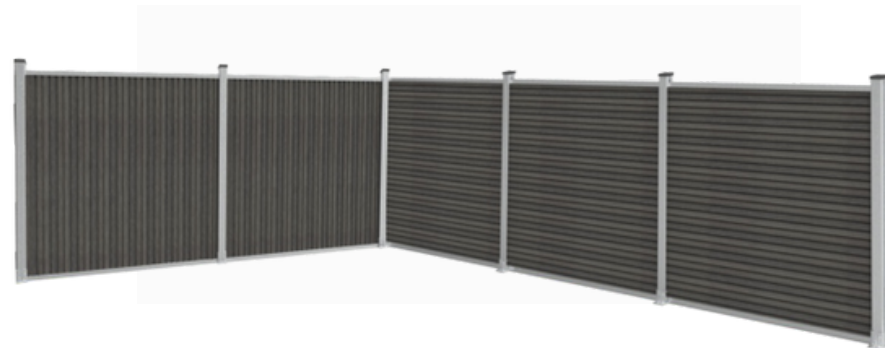
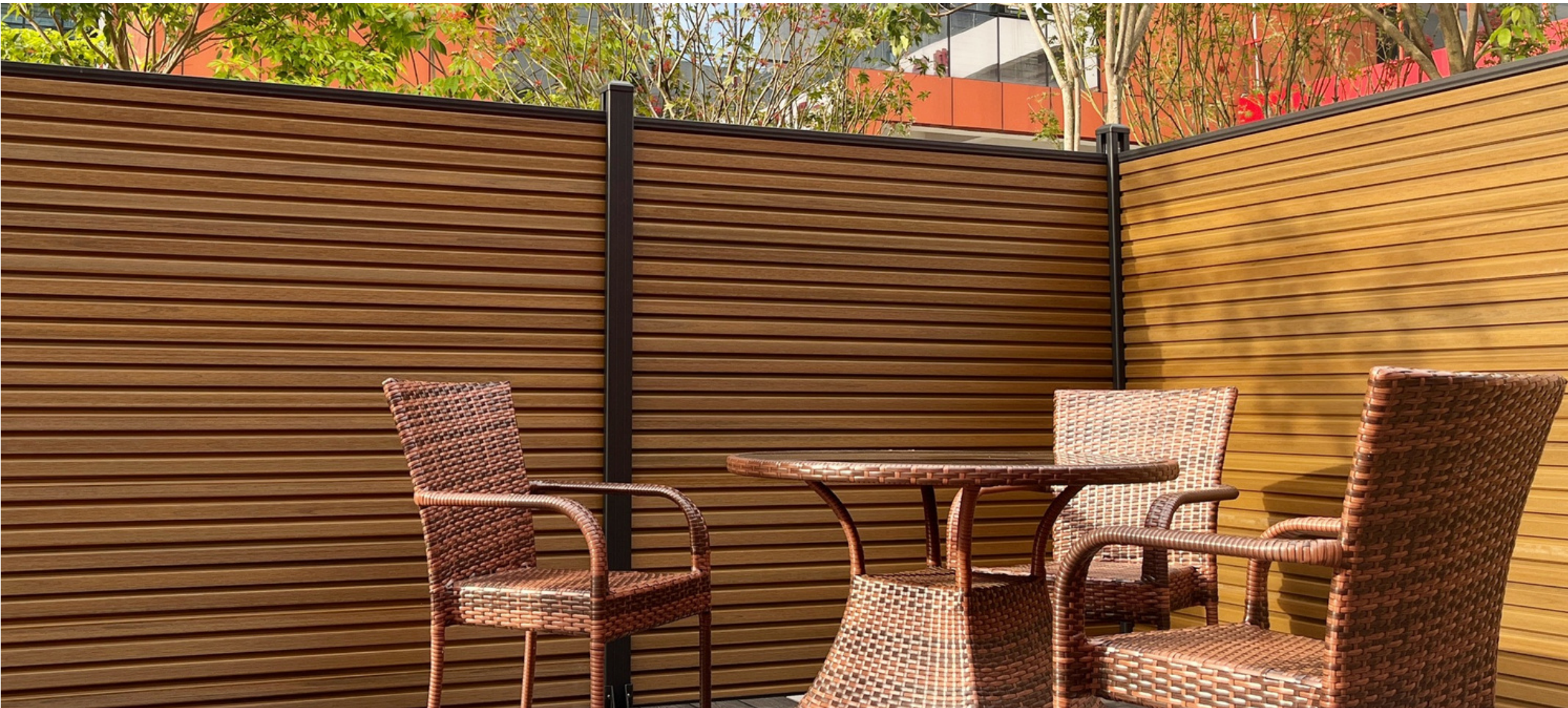

Introducing our innovative slatted design, a fresh addition to your aesthetic repertoire. This versatile style offers the flexibility of installation in both horizontal and vertical orientations, allowing you to tailor it to your vision.

Crafted using advanced co-extrusion WPC material, the panels boast remarkable scratch resistance, ensuring their enduring beauty over time. Cleaning becomes a breeze, thanks to the material's enhanced ease of maintenance.

Enhancing the installation experience, the fence posts are constructed from lightweight yet sturdy aluminum material. This strategic choice not only ensures durability but also streamlines the installation process, making it effortlessly convenient.

Experience the fusion of style, functionality, and convenience with our slatted design fencing solution.

Standard Size:
W1800mm X H1800mm
W1800mm X H1150mm

S-CF03
176X24mm

Patented design, Better strength

COMPONENTS

Post	Rail	Side Cover	L-fix	Post Base	Cap

COLOR OPTIONS



Firenze Series





Standard Size:
W1830mm X H1800mm
W1830mm X H1150mm





S-CF01
180X24mm

COMPONENTS

Post	Post Part 1	Post Part 2	Post Part 3	Rail	L-fix	Post Base	Cap
							

COLOR OPTIONS



Introducing our latest innovation: the Firenze Series. Setting itself apart from our previous offerings, this series employs cutting-edge co-extrusion technology for both boards and posts, resulting in a remarkable upgrade.

Experience the pinnacle of performance with waterproof, mildew-proof, and UV-resistant attributes that ensure lasting quality and visual appeal. The boards and posts share an identical color palette, creating a seamless and harmonious aesthetic unity.

With a plethora of colors and designs at your fingertips, this series empowers you to curate your garden's ambiance effortlessly. Elevate your outdoor space with the Firenze Series—a testament to both form and function.



Accessories and Colors

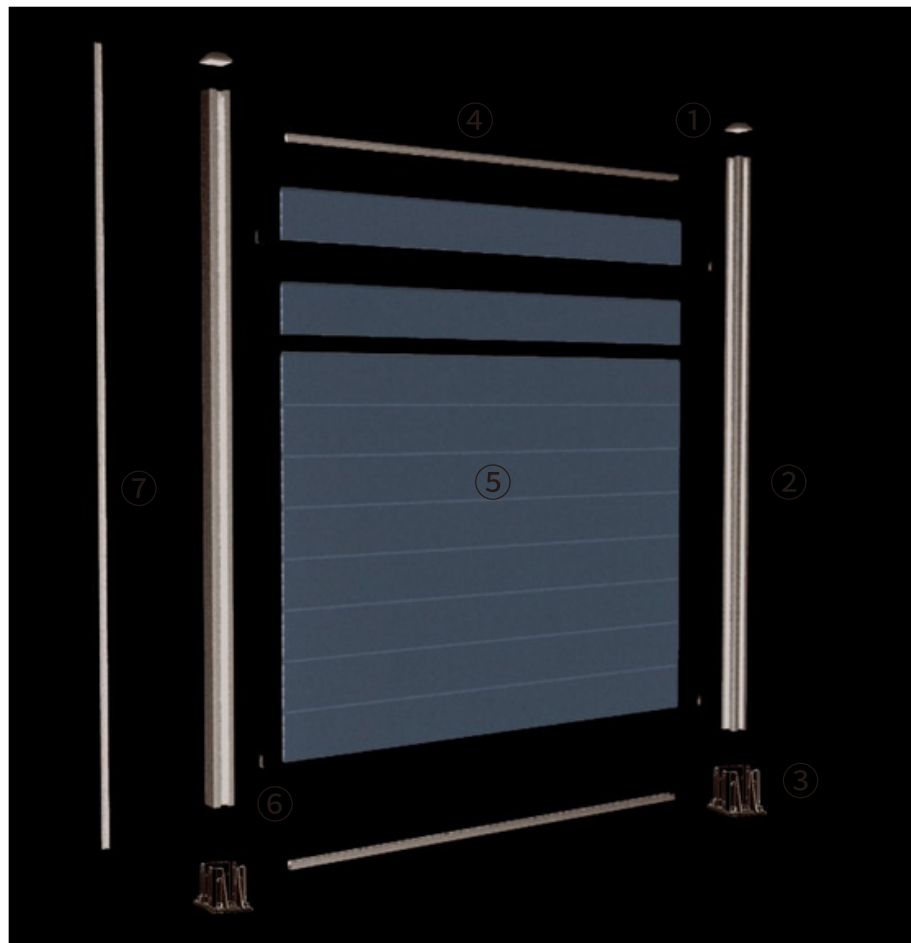

- ① Post Cap
- ② Post
- ③ Base
- ④ Rail
- ⑤ WPC Board
- ⑦ Side Cover
- ⑥ L-fix

Installation

1. Installation of Post

A. Fixing Post by using Post Base.

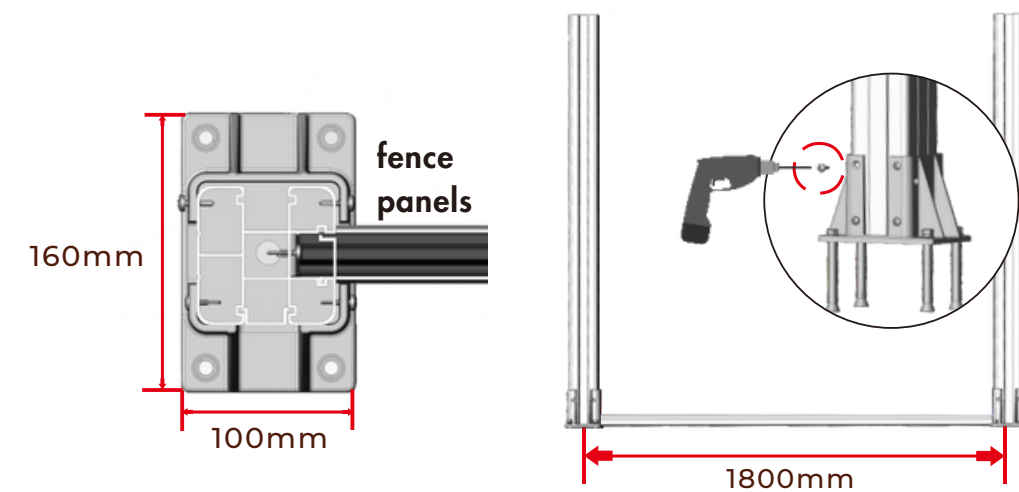

2. Install the bottom rail, using bracket to connect rail with post.

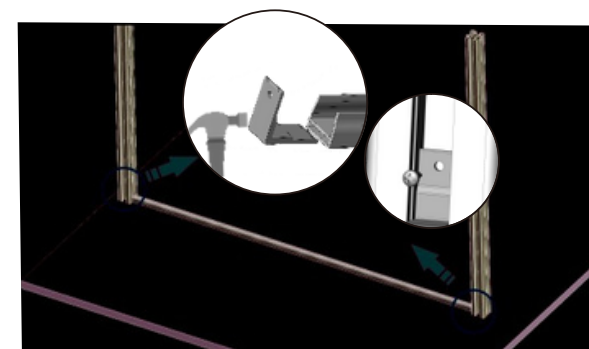

3. Install the wpc panels one by one.

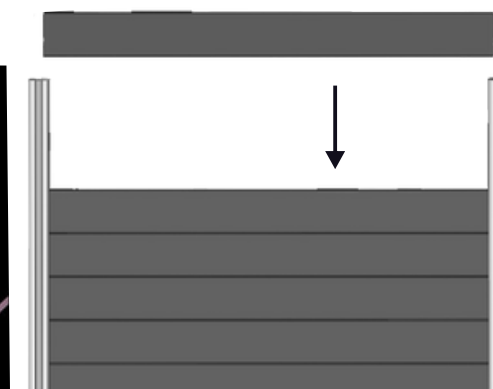

B. Fix the aluminum posts with cement. 500mm into the soil.

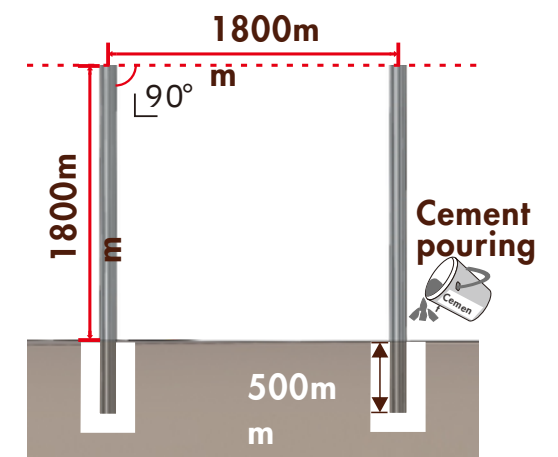

4. Install the top rail and post cap.

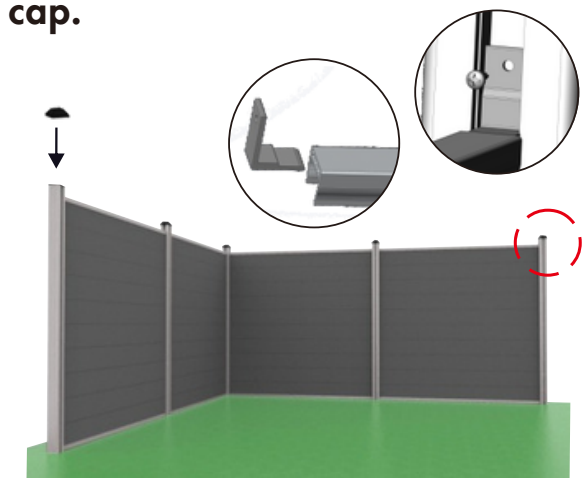

COLOR OPTIONS



Post Colors

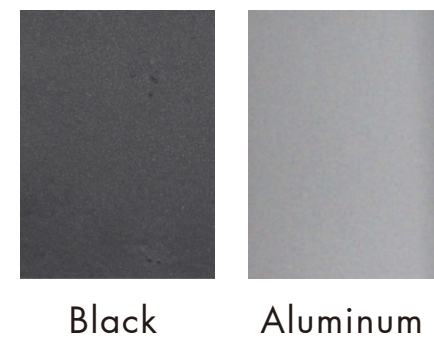

EXCLUSIVE BASES

NEW PATENTED DESIGN

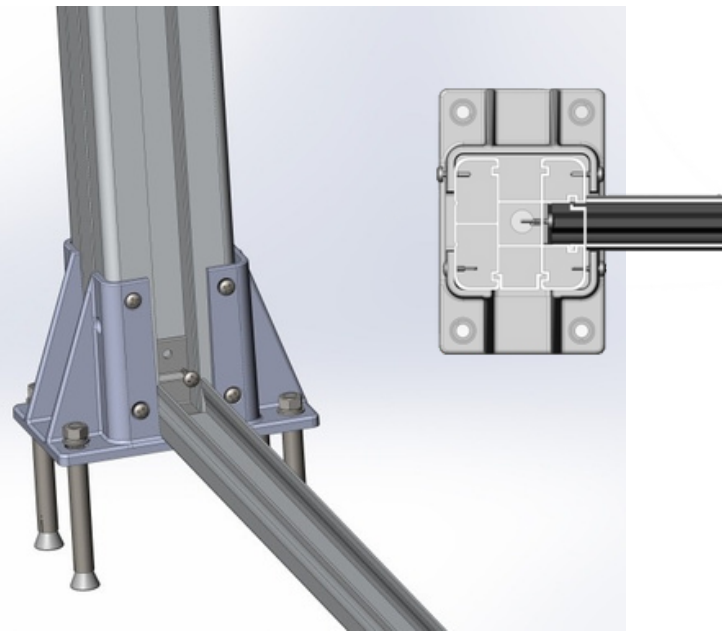

To enhance the capacity to withstand higher wind loads, we have opted against welding for our foundation. This decision arises from the foundation's susceptibility to instability during storms. Furthermore, we have conducted a comprehensive redesign of the foundation, implementing additional reinforcements to bolster the overall system's strength. This strategic enhancement ensures a more robust structure capable of enduring challenging conditions.

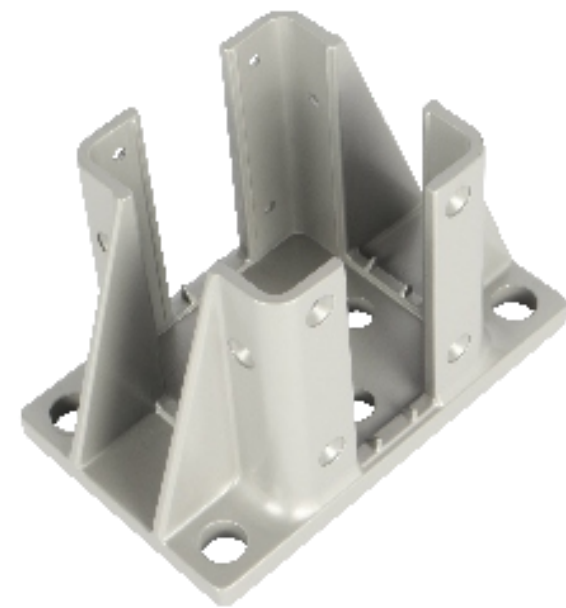

Aluminum



Black

Fence LED



Regular Fence Gate

Upon installing your fence, a gate designed to perfectly match your garden's fencing is essential. **ARTIGIANO DESIGN** has established a dedicated fence gate processing department to cater to our customers' diverse application requirements. Our fence gates are skillfully crafted by combining fence panels with aluminum frames, ensuring a seamless structural alignment with the fence itself, exuding an air of sophistication and contemporary style. Featuring an easily detachable assembly, this product allows for hassle-free maintenance, with the added convenience of replacing individual fence panels whenever needed.

Double Swing Gate



Single Swing Gate



Standard size:
W 900 x H 1700 mm



COLOR OPTIONS



Electric Fence Gate

ELECTRICAL FOLDED SWING GATE



TURNING SECTIONAL SLIDING GATE



SLIDE GATE ON FENCING



TELESCOPIC GATE



ELECTRICAL SWING GATE



GATE DOORS

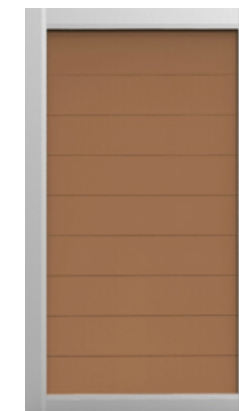

Style A



Style B

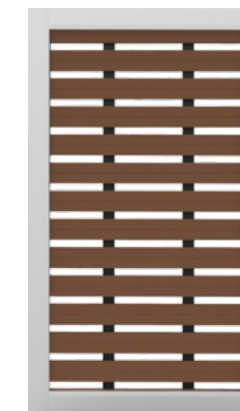

Style C



Style D

COLOR OPTIONS



PAST PROJECTS



- 1. China
- 2. China
- 3. Guan
- 4. Canada
- 5. Holland
- 6. USA
- 7. China
- 8. Maldives

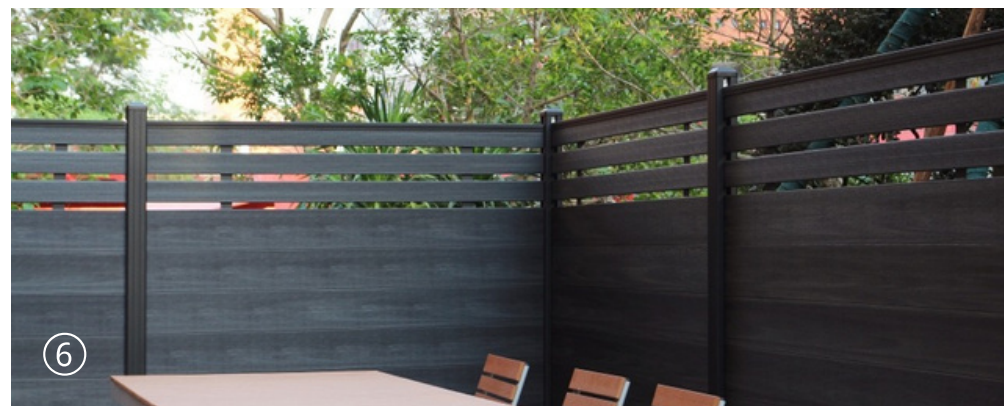
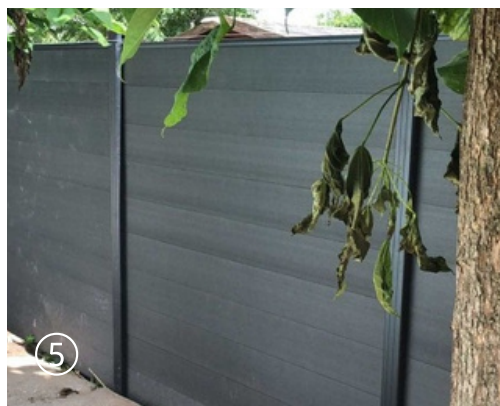

PAST PROJECTS





Contact@ArtigianoDesign.com

www.ArtigianoDesign.com